



OPERATING INSTRUCTION MANUAL

FOR

INDICATOR/ALARM UNIT NC-591

● **Request for the Customers**

- Read and understand this operating manual before using the detector.
- You must operate the detector in accordance with the operating manual.
- Regardless of warranty period, we shall not make any compensation for accidents and damage caused by using this product.

The compensation shall be made only under the warranty policy of products or parts replacement.

- Because this is a safety unit, a regular maintenance for every six months and daily maintenance must be performed.
- If you find abnormalities in the detector, please notify them to our local representative immediately.

RIKEN KEIKI Co., Ltd.

2-7-6 Azusawa, Itabashi-ku, Tokyo, 174-8744, Japan

Phone : +81-3-3966-1113

Fax : +81-3-3558-9110

E-mail : intdept@rikenkeiki.co.jp

Web site : <http://www.rikenkeiki.co.jp/english/>

INDEX

1. PRODUCT OUTLINE	
1-1. In the beginning	3
1-2. Application for use	3
1-3. Identification of each cautional marks	3
2. IMPORTANT INSTRUCTION FOR THE SAFETY	
2-1. Danger items	4
2-2. Warning items	4
2-3. Caution items	5
3. PRODUCT FUNCTION	
3-1. External drawing	6
3-2. Appearance	6
3-3. Panel cut-out dimensions	7
3-4. Name of each part and function	8
3-5. Block diagram	9
4. HOW TO USE	
4-1. Before operation	10
4-2. Mounting/dismounting procedures	10
4-3. Installation place	11
4-4. Caution in the system engineering	12
4-5. Grounding	15
4-6. Wiring	16
5. OPERATION METHOD	
5-1. Start-up	17
5-2. Basic performance flow	17
5-3. Start-up method	
5-3-1. Power on	18
5-4. Explanation of performance (Detection mode)	
5-4-1. Display action	19
5-4-2. External output action	21
5-5. Maintenance and adjustment	
5-5-1. Maintenance mode	22
5-5-2. Zero adjustment	23
5-5-3. Confirmation of alarm level	24
5-5-4. Change of alarm level	24
5-5-5. Confirmation of peak hold level	25
5-5-6. Alarm test	26
5-6. How to finish operation	27

6. KIND OF ALARM AND PERFORMANCE	
6-1. Kinds of alarm	28
6-2. Gas alarm	
6-2-1. Gas alarm action	28
6-2-2. Counteraction at gas alarm	29
6-2-3. Gas alarm possibility except the case of gas detection . .	29
7. MAINTENANCE CHECK	
7-1. Frequency of maintenance and check items	
7-1-1. Daily check	30
7-1-2. Regular maintenance check	30
7-2. Maintenance contract for regular check	30
7-3. Replacement of sensor and parts	31
7-4. Treatment when operation is stopped or its installation place is moved	
7-4-1. Stop at normal operation	31
7-4-2. Installation when move its place	31
7-5. Storage and treatment when not use for a long time	31
8. SCRAP OF PRODUCTS AND SENSORS	31
9. TREATMENT AT ABNORMAL CASE	
9-1. Trouble alarm	32
9-2. Counteraction at trouble alarm	32
9-3. Before it is thought to be trouble	32
9-4. Trouble shooting	32
10. DEFINITION OF WORD	34
11. PRODUCT SPECIFICATION	
11-1. Specifications	35
11-2. Product composition	36

1. PRODUCT OUTLINE

1 — 1. In the beginning

First of all, we wish to express our heartfelt thanks for your purchase of our indicator/alarm unit NC-591. This instruction manual is just a guide book to operate indicator/alarm unit NC-591 of RM-590 series. Your kind reading of this manual is requested not only for first user but for already experienced staff.

1 — 2. Application for use

- This is an exclusive indicator/alarm unit to be used in combination with our new ceramic sensor type combustible gas detector head.

1 — 3. Identification of each cautional marks



Indicates an imminently hazardous situation which, if not avoided, will result in death or serious injury. This signal word is to be limited to the most extreme situation.



Indicates a potentially hazardous situation which, if not avoided, could result in death or serious injury.



Indicates a potentially hazardous situation which, if not avoided, may result in minor or moderate injury. It may also be used to alert against unsafe practices.

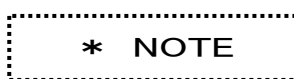

This means “ADVICE” at operation.

2. IMPORTANT INSTRUCTION FOR THE SAFETY

2—1. Danger items



This is not an explosion proof unit. Do not use it at hazardous area. Operation under such environment is very dangerous.

2—2. Warning items



- **Detector head**
Do not connect other detector head than designated combustible gas detector head.
If connected, you can not detect gas. Furthermore, this unit or other connected unit may be broken.
- **Power source**
Before supplying the power, confirm that the power source is a designated voltage.
- **Necessity of protective grounding**
Do not cut inside or outside wire for earth, nor disconnect the wire from earth terminal.
In any case, the unit becomes dangerous conditions.
- **Defect of protective function**
Do not operate the unit if protective functions such as protective grounding or fuse are seems to be defective.
Also, before operating the unit confirm that there is no defect for protective functions.
- **Fuse**
Use the designated rating (current, voltage, type) fuse to prevent fire.
Replacement of fuse shall be done after put off the initial power source and put off the power switch of this unit.
Do not use other fuse than designated one, nor make short circuit for fuse holder.
- **External connections**
After making protective grounding firmly, connect to external control circuit or detection objective.
- **Counteraction at gas alarm**
When detect high concentration gas than preset alarm level, it is very dangerous.
It is required to take an appropriate measures by customer's decision.
- **Mounting/dismounting**
Locking mechanism may be broken if the unit is mounted into the case with disengagement lever up position. Make correct procedure for mounting/dismounting.

2—3. Caution items



- Do not use walky-talky near this unit.
When this unit receives the electric waves by walky-talky etc near from the cable, this will effect the reading.
When use the waky-talky, operate it at the place where there is no influence of electric wave ejection.

- When make power on again, make it after an interval of over 5 seconds.
When make power on within 5 seconds, there may be no normal operation.

- When operate it not to follow this manual, repair it by other rating parts or modify it on his own, the safety and quality of products can not be secured. Then, when an accident take place by it, we cannot assure our responsibility on them.
Take enough consideration for instrumentation to keep safety even if disconnection of power and signal lines, defect of operation or trouble would be happen due to unexpected reason.
This is an electrical applied instrument.
Be care it may be effected by power noise, electrostatic and electromagnetic noise.
When use under such conditions, make protective treatment for use.

3. PRODUCT FUNCTION

3-1. External drawing (with single case)

*Refer to the operating instruction manual for multi-unit case when multi-unit case is used.

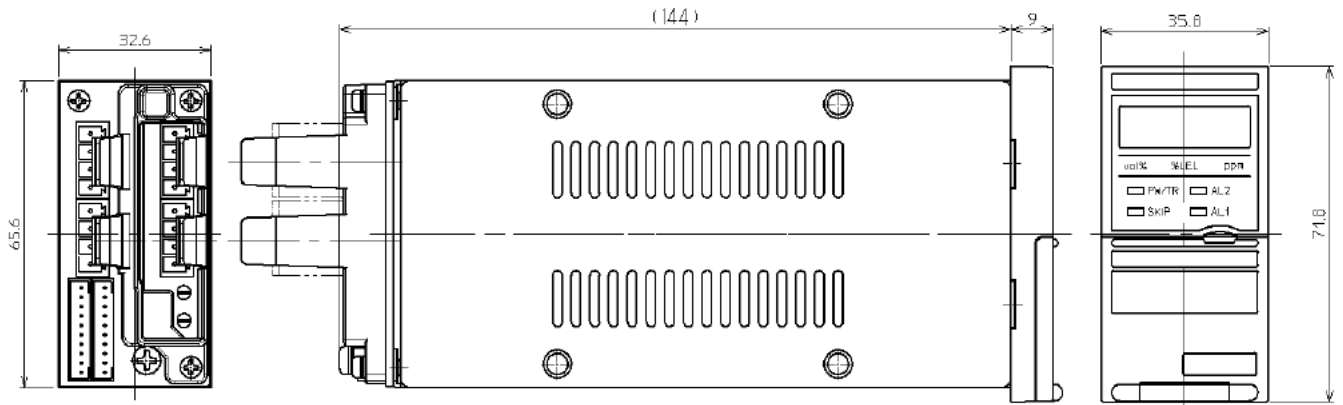

3-2. Appearance (with single case)

*Refer to the operating instruction manual for multi-unit case when multi-unit case is used.

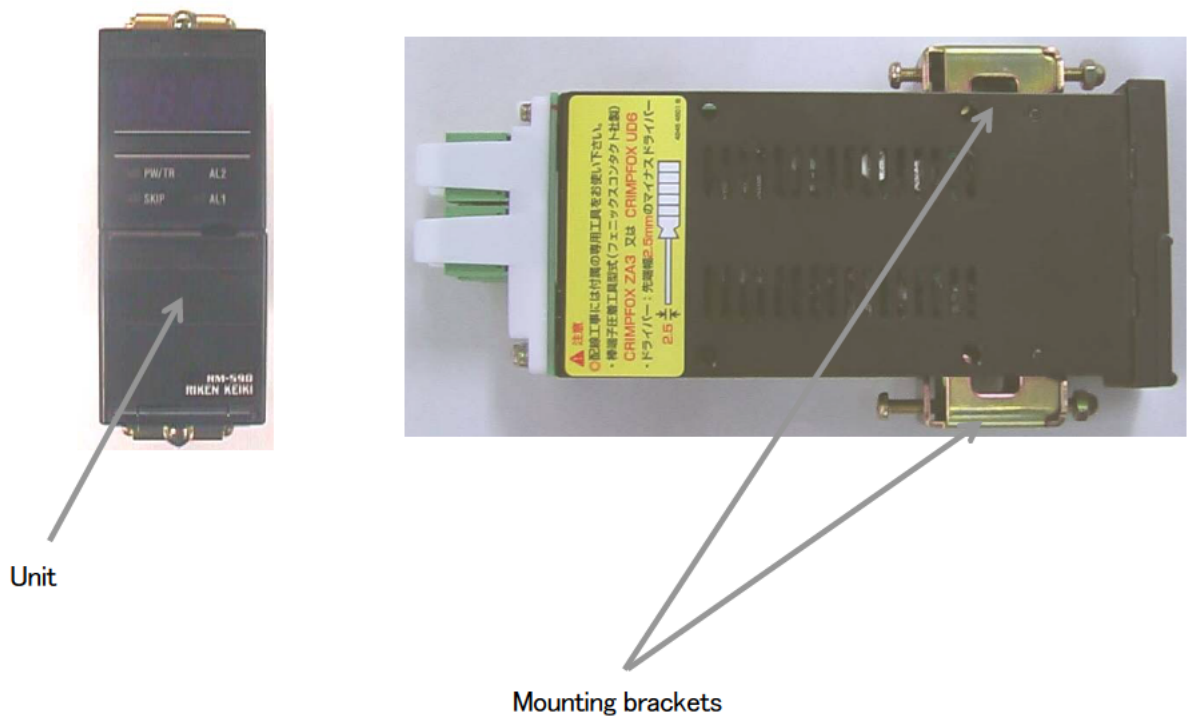

3—3. Panel cut-out dimensions

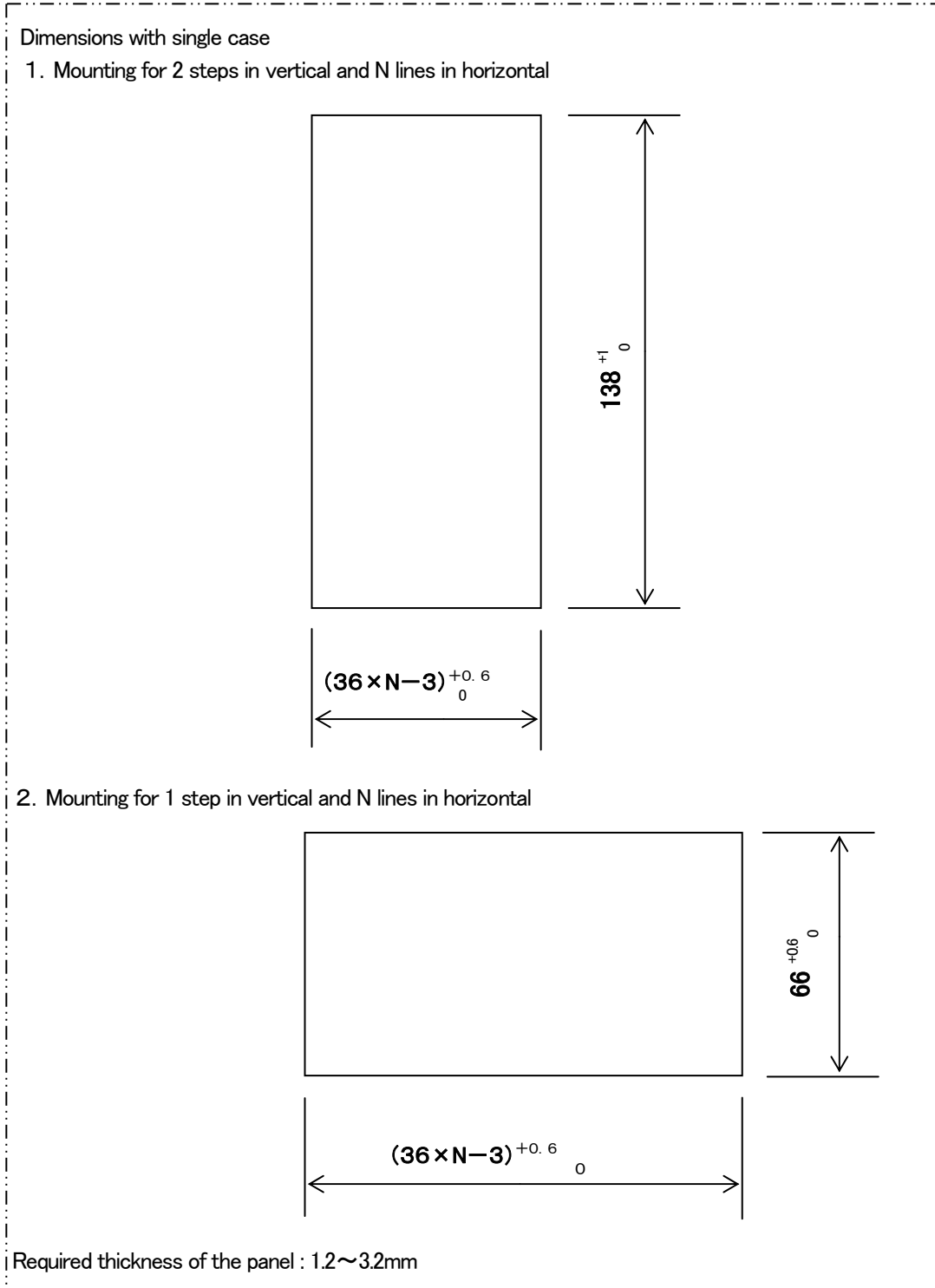

Refer to the instruction manual for multi-unit case if installed the unit to multi-unit case.

 **CAUTION**

Please consult us or with our agent for installation method or installation quantity to avoid trouble caused by radiating heat.

3—4. Name of each part and function

*The below pictures show indicator/alarm unit with single case.

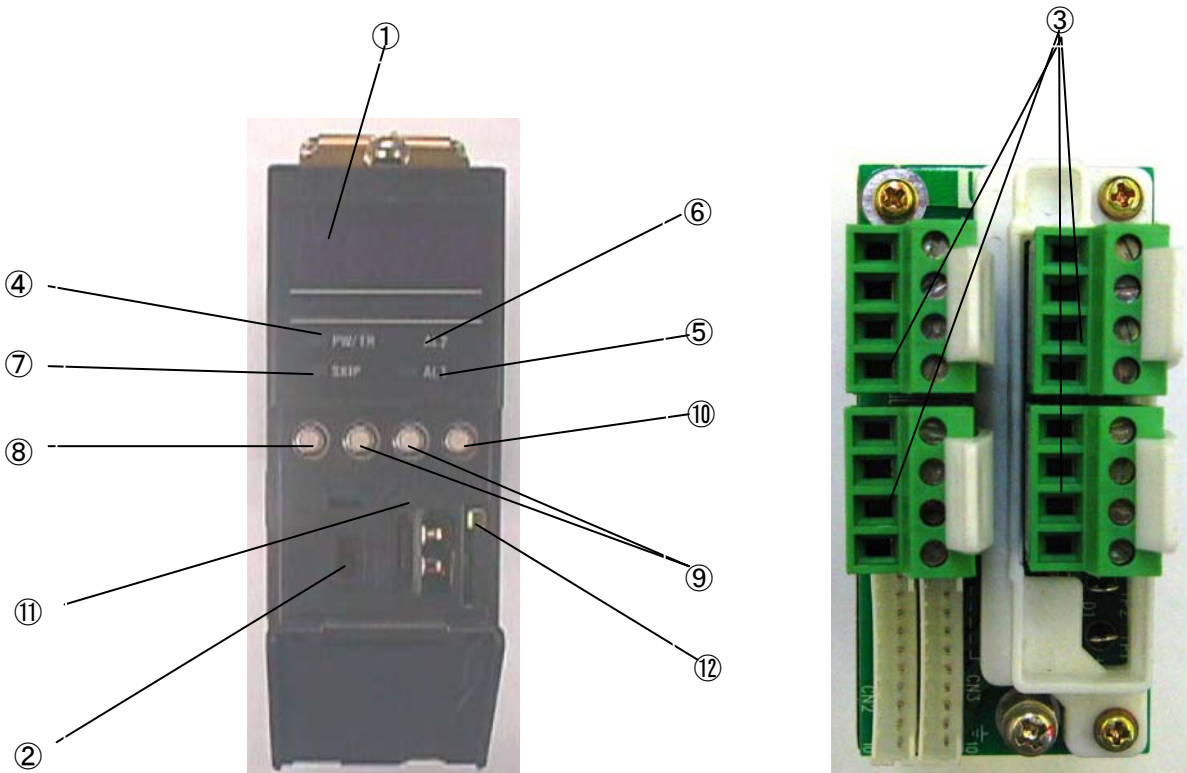

- ①LED display..... Indicates gas concentration.
- ②POWER switch..... ON/OFF switch
- ③Terminal plates..... Connects cables from outside.
For multi-unit case refer to instruction manual for multi-unit case.
- ④PW/TR light..... Combination light for power and trouble indication.
Steady light : Power ON, normal operation
Flashing : Trouble
- ⑤AL1 light..... Flashes at gas alarm (1st alarm)
- ⑥AL2 light..... Flashes at gas alarm (2nd alarm)
- ⑦SKIP light..... Flashes during maintenance mode.
- ⑧MODE switch..... Uses at maintenance work.
- ⑨UP/DOWN switch..... Uses to select items at maintenance mode, increase or decrease reading at zero and span adjustments, and to increase or decrease reading at alarm test.
- ⑩SET switch..... Uses to change for alarm test mode.
- ⑪HEAT control knob Uses to adjust the heater voltage of the sensor.
- ⑫Disengagement lever..... Locks the indicator/alarm unit.

3-5. Block diagram

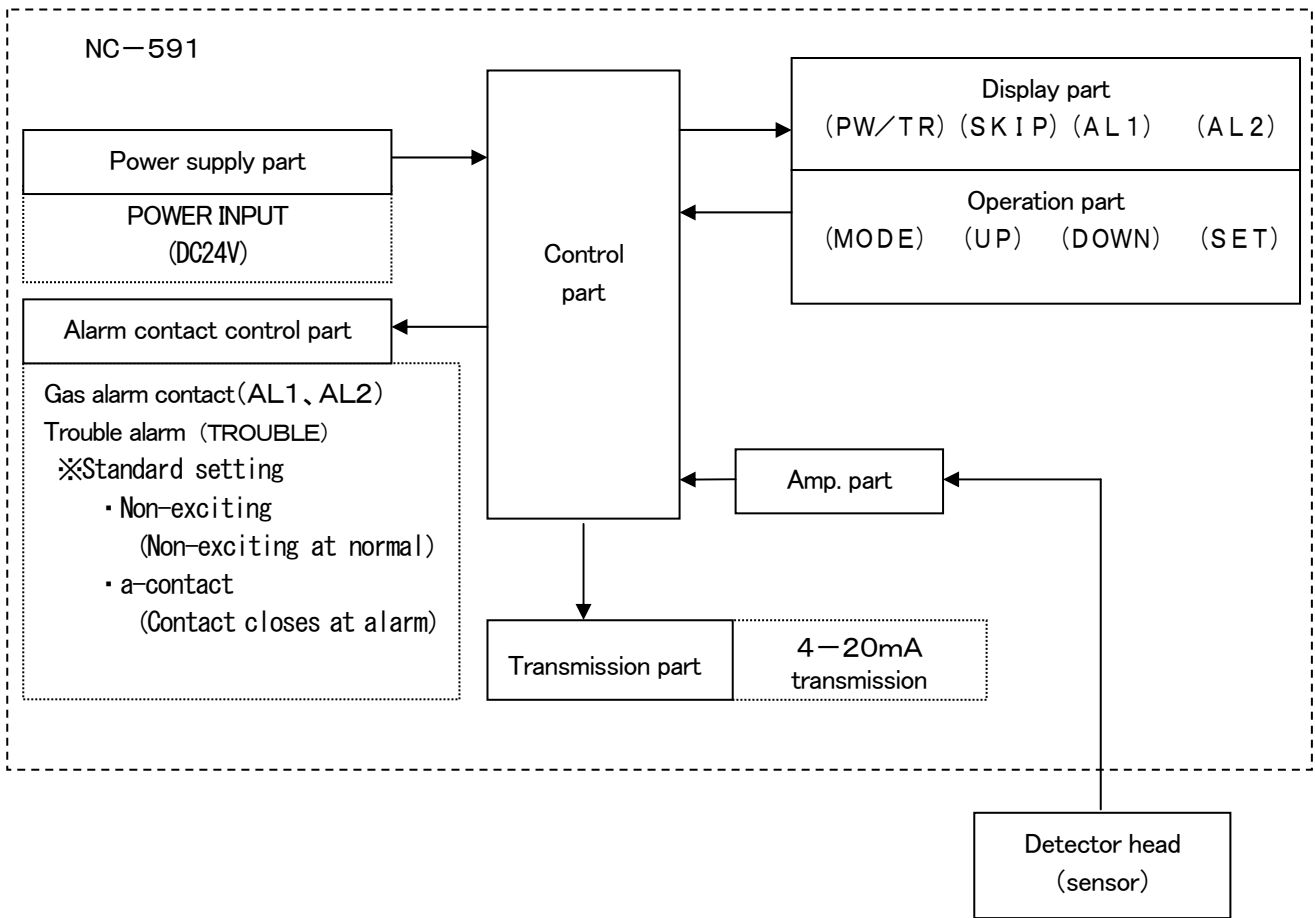

4. HOW TO USE

4 — 1. Before operation

Be sure to keep cautional items of use not only for first user but for already experienced staff.

If not keep these cautional items, the unit may be defective and correct gas detection may not be performed.

4 — 2. Mounting/dismounting procedures

Indicator/alarm unit for RM-590 series shall be used after housing it in either exclusive single case or multi-unit case.

(1) Mounting method

- Open the front cover of this unit.
- Confirm that the power switch is at OFF
- With the disengagement lever at down position, mount into the case.
(Confirm that the edge connector is put in firmly)
- Confirm that the disengagement lever is turned upward when indicator/alarm unit is mounted into the case firmly.
- After confirmation of lever position, put ON the power switch, and then, close the cover.

(2) Removal of the unit

- Open the front cover of this unit.
- Confirm that the power switch is at OFF.
- Push disengagement lever down to release the lock.
- Pull out the unit from the case.
- Turn the lever upward and close the cover.

CAUTION

Mounting/dismounting of indicator/alarm unit shall be done according to the above procedures. If not, stopping metal of the unit may be transformed and the cover can not be closed.

4 — 3. Installation place

CAUTION

Do not install at places where direct sun drought or where the temperature is drastically changed.

Keep away the system from direct sun drought or where the temperature of the system is drastically changed.

Do not install it where vibration or shocks may take place.

The system consists of fine electronics parts.
Install them where to be stable not to crush or fall down.

Keep the system from the equipment which may generate the noise (Unit & cable).

Keep the system from the equipment which may give a high frequency in the surroundings and install it.

•Do not put the system jointly each. •Do not wire the cable in parallel nor take access.

Do not install it where the detection gas is deposited around.

Do not install and make gas detection at the place where the sample gas is deposited.

Do not install at the place where it is danger for maintenance service such as high voltage cable, etc.

This unit is required to make maintenance regularly.
Then, do not install at the place where there is danger at maintenance time.

Do not install it where it is unable to make maintenance.

When required to stop the system at maintenance time, unable to maintain if not remove a part of system or unable to detach the case due to the pipe or rack etc. do not install such place.

System housing that grounding construction is not enough.

Be sure to ground when install.

4 — 4. Caution in the system engineering

 **CAUTION**

Unstable power and noise may cause error of performance and alarm.
For the system to use this unit, it is required to make design based on this manual descriptions.

(1) Stable power used

While the system gets stable at power failure, the external output and alarm contact may be on and the care for it must be taken. In such case, use the standby battery or take an appropriate action in the receiver side.
Supply the following power to this unit

Power voltage	DC24V±10%
Power failure tolerance time	Approx 50msec. (For power failure of 50msec, it re-starts) To warrant the continuous operation, install the standby battery outside.
Others	Do not contact with power involving high power load and high frequency noise. According to requirement, use line filter and separate it from noise source.

(2) Designing to consider radiation

When install the closed self-standing control panel, mount the fans in the upper and lower part.

(3) Lightning measures

Lightning surge	There is the problem "Lightning". When make outdoor wiring of cable at factory or plants etc or when make a parallel wiring in the same duct with the cable in from outdoor even at the indoor wiring. If the lightning is a huge generation source, the cable is a reception antenna and there is the case that cable connecting instrument is broken. It is impossible to prevent the generation of lightning. If the cable should put in metal tube or laid in the underground, it is impossible to prevent the inductive lightning surge generating from the thunder.
Lightning measures	There is not the complete countermeasure for it but the following method can be considered. Make the suitable treatment accordingly. a) The transmission signal route is arranged for connection by the optical fiber cable etc. b) Countermeasure by the lightning arrester (Cable safety retainer). There is the way to install the lightning arrester just before the field apparatus and the central control station. The position of the lightning arrester installation is at each point of cable laid out from the outdoor to the indoor. The lightning arrester builds in the circuit to remove the surge voltage to be the source for the damage of field apparatus (Protection resistor, zero diode etc.) and is designed to protect the apparatus. But as the signal may be attenuated due to the lightning arrester, check the action and it is required to use.
Grounding	Surge noise shall be generated from the thunder lightning or except it. To protect detector from these cause, be sure to make grounding.

* In the lightning rod, there is the circuit to remove the surge voltage to be a cause of damage from field instruments. By installing the lightning rod, the signal may be attenuated. When install the lightning rod, it is required to check the performance in advance.

(4) Alarm contact

• Alarm contacts shall be used only for external buzzer and alarm light, and do not use it for the controlling use (such as solenoid valve control etc).

When control the external load, the bad influence may be given to the system according to the load characteristics. In such case, the following countermeasure shall be taken to stabilize the action and protect the contents.

• Relay (make contact amplification) by the low voltage relay and operate by connecting CR circuit (Spark Killer: SK) (Diode etc for DC) suited for relay coil directly to relay.

• Add CR circuit to the load side of relay on the request.

 **CAUTION** (FOR USE OF NORMALLY-CLOSED CONTACT)

Normally-closed contact (Break contact) at non-existing condition may change to open contact in a moment due to physical shock.

Whenever alarm signals from gas detectors are used with normally-closed contact, please put delayed-circuit (for about one second) to receiver side of normally-closed contact to avoid such phenomenon.

Reference :By the condition of load, CR circuit may be better to install in the contact side but it is required to put in by checking the action of load.

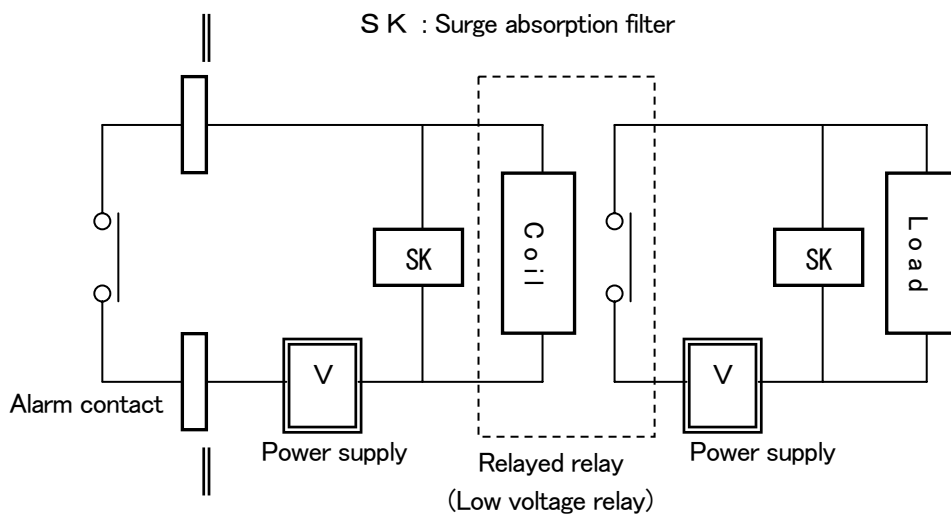

NC-591

—How to think alarm contacts against inductive load—

The spec for alarm contact of NC-591 is described by the conditions of resistive load. When use the inductive load for alarm contacts, the very high reverse electromotive voltage may be generated and the following trouble tends to be produced.)

- Contact part of relay is melted adhesively and the contacts can no work.
- High voltage is put inside of indicator/ alarm unit and then, electrical parts may be damaged.
- As it is big noise, the trouble action may be taken by the reckless drive of CPU.

 **CAUTION**

- The inductive load shall not be used in principle(Do not use fluorescent lamp).
- When use the inductive load, make the contact amplification outside, but the outside relay coil belongs to the inductive load, use the relay driven by the low voltage(within AC100V) and it is protected by an appropriate surge killer.
- When control the light inductive load directly, protect the contacts by an appropriate surge killer by all means.

※ As the inductive load, there are following samples.

- Revolving light * External relay * Buzzer *Siren *Fan *Fluorescent lamp * Motor etc.

4—5. Grounding

Make grounding with terminal 

WARNING

Be sure to make grounding before putting power ON.

*The above fig shows the unit with single case. In case of multi-unit case, refer to instruction manual for multi-unit case.

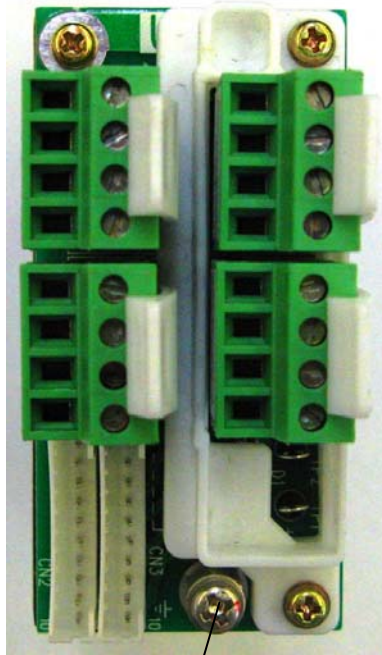

Terminal 

Be sure to make grounding for safety purpose and to keep stable operation of this unit.

Do not connect each wire with gas pipe. Make grounding corresponding to D-class grounding (Grounding resistance : below 100 ohms).

4—6. Wiring

(In case of single case)

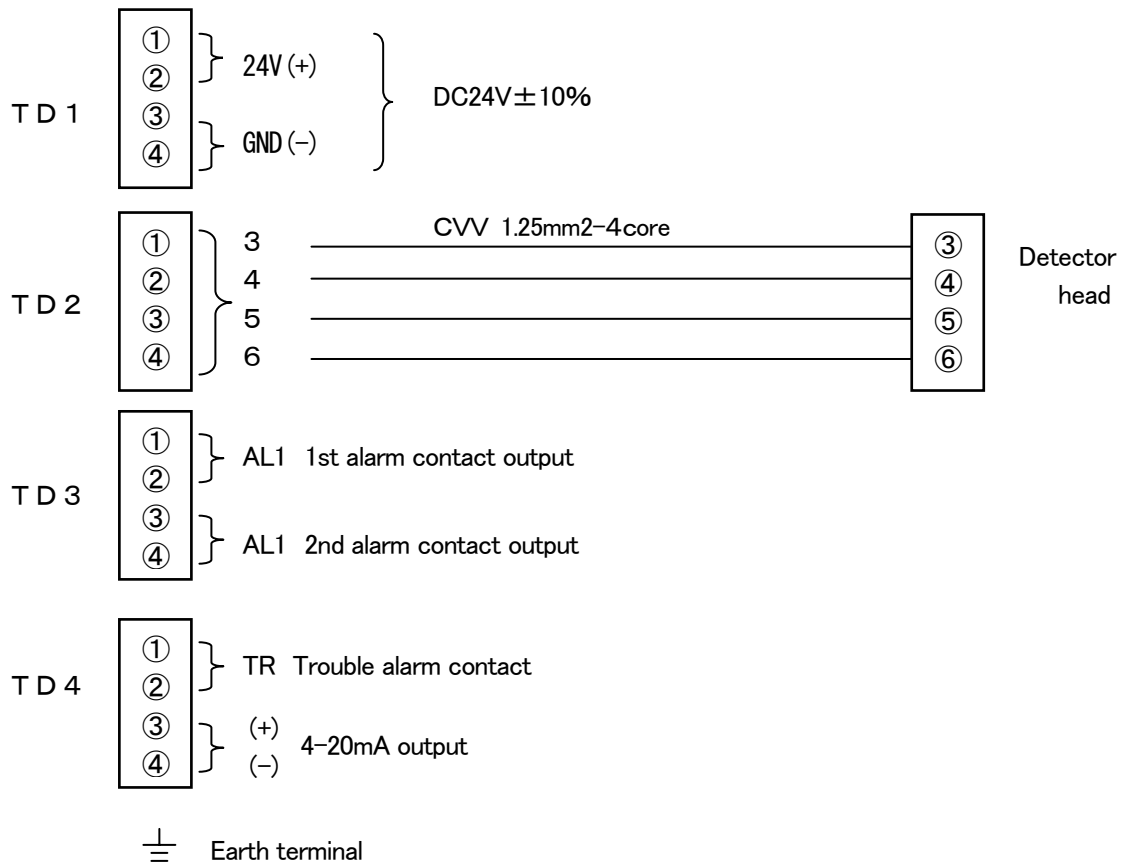

Maximum cable length : 1.25km

For multi-unit case, refer to operating instruction for multi-unit case.

CAUTION

- Use CVV 1.25mm² cable for connection of detector head.
- Do not distribute power cable, detector head cable and signal cable together with power line for motor, etc.
- This unit applies a connector type terminal plate for easy wiring (for single case). Be care not to give a high load to the connector.
- We can not warrant the performance of this unit if undesigned cable is used.

5. OPERATION METHOD

5-1. Start-up

● Before putting power ON

Before putting power ON, keep following caution items. If not, danger for electric shock or damage to the unit will be happen.

- (1) Make grounding.
- (2) Check that wirings with outer units are made correctly.
- (3) Check that the supply voltage is within a rating.
- (4) Relay contact for outer alarm may work during adjustments. Even relay contact works, treat that any influence will not be given to the outer.
- (5) To prevent fire, check that the designated fuse is used.

5-2. Basic performance flow

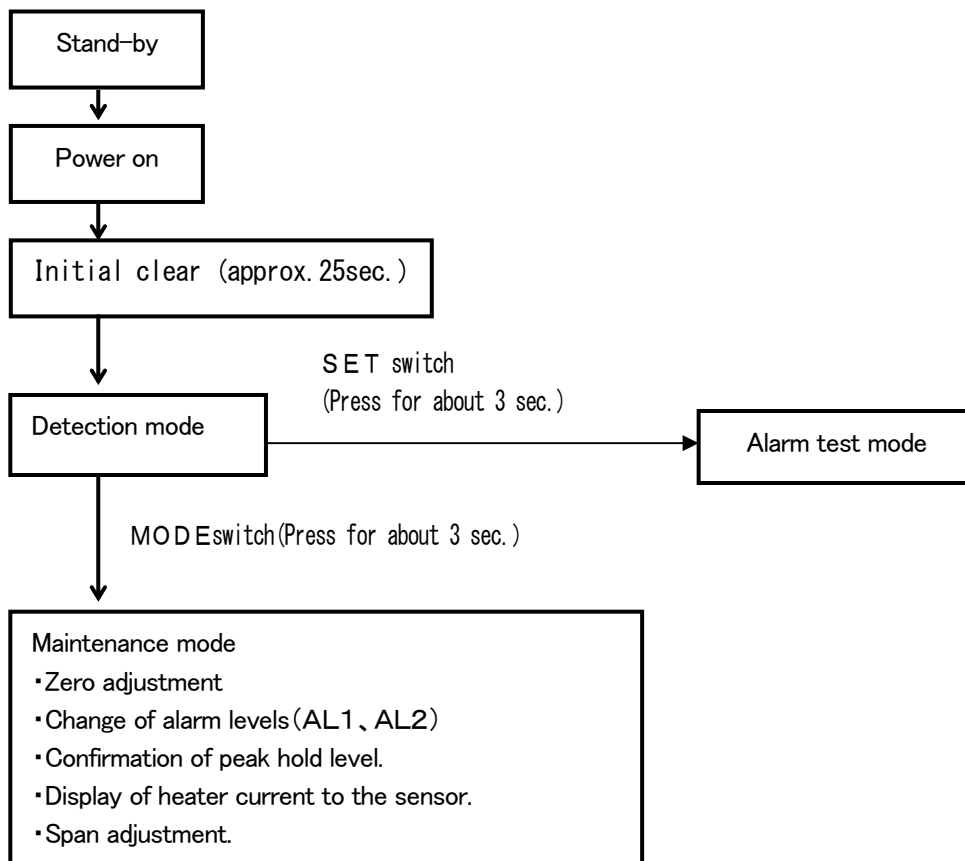

CAUTION

Maintenance mode shall be performed by the specialized service man.
Do not operate it without permission.

5—3. Start-up method

5—3—1. Power on

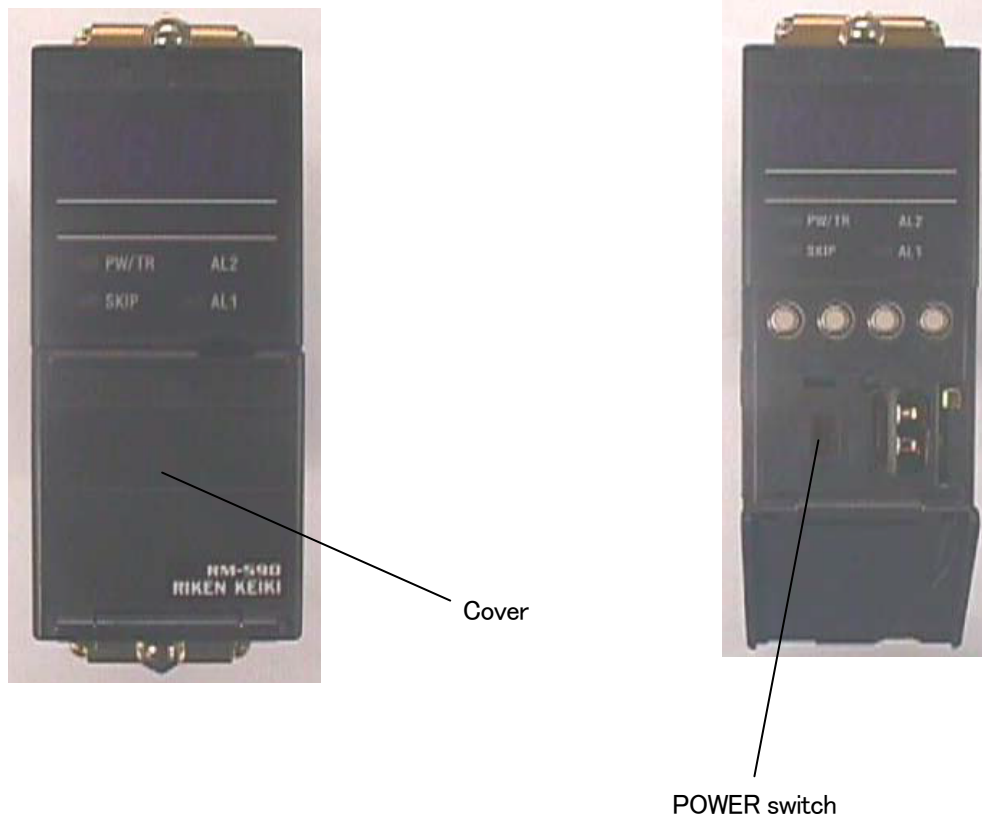

- 1) Before making power on, check that the unit is connected correctly.
- 2) The power switch can be seen when the front cover is opened.
- 3) Put the power switch upward to ON and downward to OFF.
- 4) Put the power switch on, and power light illuminates.
- 5) Status of initial clear (about 25 sec.) is displayed as “- - - -”.
 - Checking of the system (Self-diagnosis)
 - Output signal: Approx 2.5mA
 - Gas alarm, trouble alarm (light, contact) shut-off.

5-4. Explanation of performance (Detection mode)

5-4-1. Display action

There are following two kinds of displays.

- (1) LED display : Shows gas concentrations.
- (2) LED light : Shows power/trouble (PW/TR), 1st gas alarm (AL1), 2nd gas alarm (AL2) and maintenance (SKIP) condition.

* Contents of indications by LED display and LED light are different from the condition of the unit.

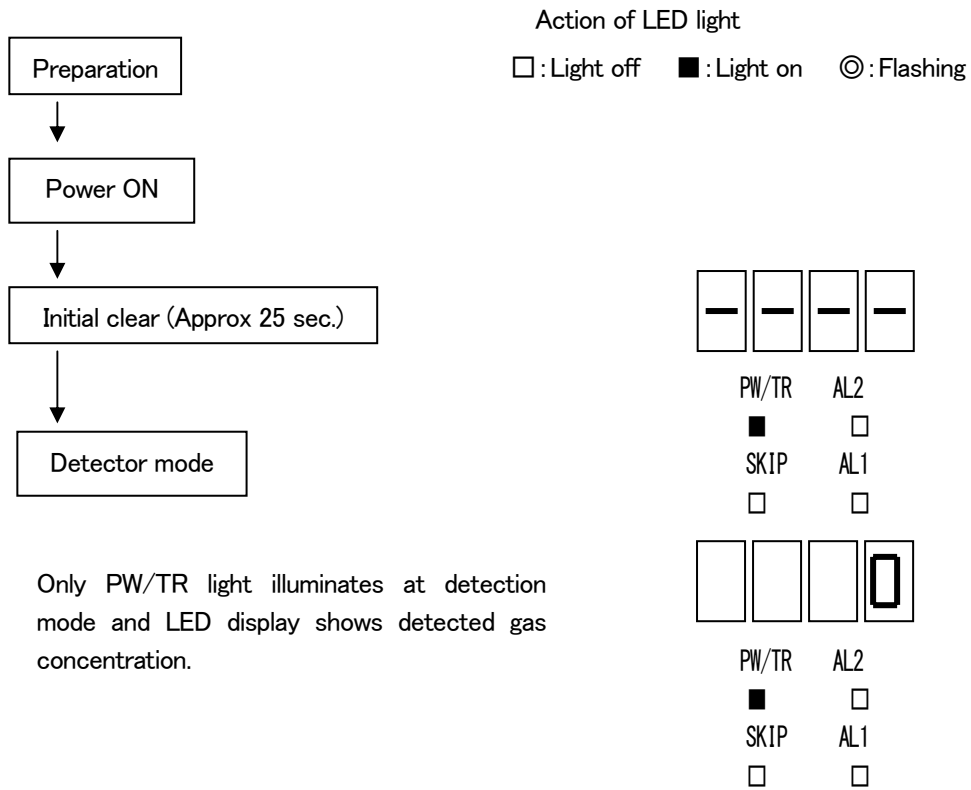

Gas alarm condition

When detect gas above AL1, AL2, it shows gas concentrations and AL1, AL2 alarm lights flash.

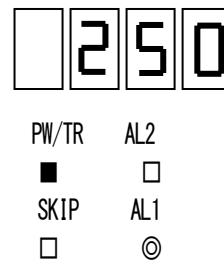

The right 「-0」 is displayed when it gets down to minus (-) side more than 10% of full scale.



PW/TR	AL2
■	□
SKIP	AL1
□	□

 **WARNING**

When it shows 「-0」, accurate gas reading is impossible and make zero adjustment.

Trouble condition

When any of trouble arises on gas detection, PW/TR light flashes and content of trouble is shown on LED display.



PW/TR	AL2
◎	□
SKIP	AL1
□	□

- | | |
|---------------|--|
| (LED display) | (Content of trouble) |
| E-00 | System trouble |
| E-01 | Sensor/detector head disconnection or not yet connected. |
| E-04 | Auto-zero function trouble. |

5-4-2. External output action

1. 4-20mA output version

- (1)Signal transmission method : Electric current transmission (Non isolation)
- (2)Transmission path : CVV
- (3)Transmission distance : Below 1 km
- (4)Resistive load for connection : Below 300 Ω
- (5)Status signal level
 - ①Detection mode : 4-20mA (Depends on gas concentration)
 - ②Gas alarm : 4-20mA (By indication valve)
 - ③Initial clear : 2.5mA (Fixed)
 - ④Maintenance mode : 2.5mA (Fixed)
 - ⑤Alarm test : 4-20mA (By indication valve)
 - ⑥Trouble alarm : 0.5mA (Fixed)
 - ⑦Point skip : 2.5mA (Fixed)
- (6)Power shut-off : 0mA

Relations between 【Gas concentration】 and 【Output】 are shown below.

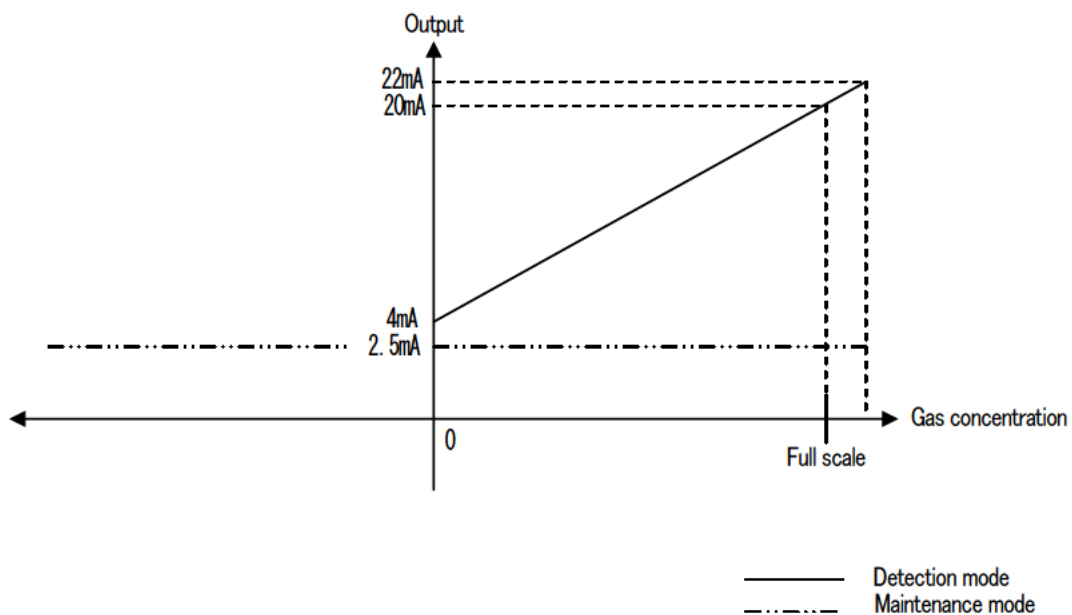

CAUTION

4-20mA outputs are already adjusted. If re-adjustment is required after installation, specialized service man will make re-adjustment.
Do not make this adjustment without permission.

5-5. Maintenance and adjustment

5-5-1. Maintenance mode

When make each adjustment, make it on maintenance mode.

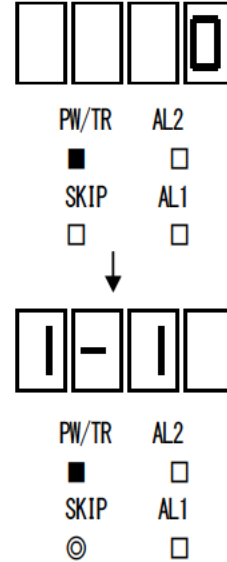
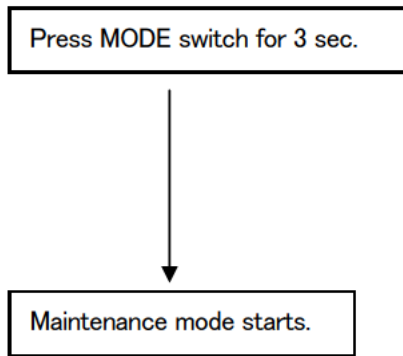

※Content of menu

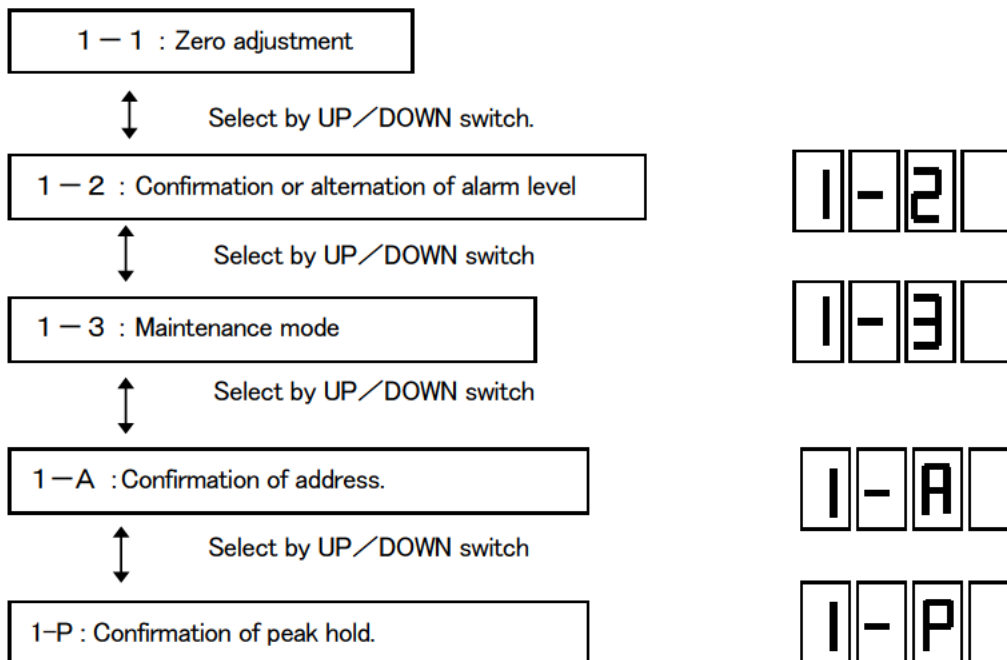

CAUTION

Do not operate 「1-3: Regular maintenance mode」 without our permission.
Please contact with our nearest agent or RIKEN KEIKI if it is required.



CAUTION

When maintenance mode starts at gas alarm, alarm contact and external output signal (gas alarm signal) will be cancelled.

5-5-2. Zero adjustment

* NOTE

When make zero adjustment, supply fresh air to the detector head and adjust it after reading gets stable.

- ① Press MODE switch for over 3 sec. to start maintenance mode.

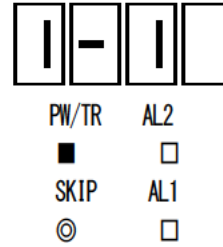

- ② Press TEST/SET switch twice. The display flashes and it can be zeroed.

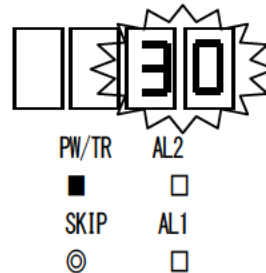

*** NOTE**
There is the case that zero reading is deviated.
At that time, make a fine adjustment with UP/DOWN switch.
After this adjustment, press SET switch.
(Zero is set by pressing SET switch).

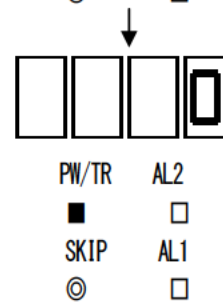

- ③ After this adjustment, press MODE switch to return MENU.
- ④ When return to detection mode, press MODE switch for over 3 sec. SKIP light gets off which shows that it is detection mode.

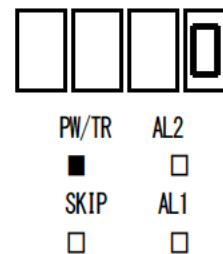
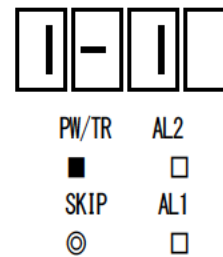

⚠ CAUTION

Gas alarm is not triggered except in detection mode.
When leave it alone on maintenance mode, this returns to detection mode automatically after 10 hours.

5-5-3. Confirmation of alarm level

This section is used to check preset alarm level.

- Press UP switch in detection mode, and the 1st alarm level(AL1) is shown. Press DOWN switch in detection mode, the 2nd alarm level(AL2) is shown.

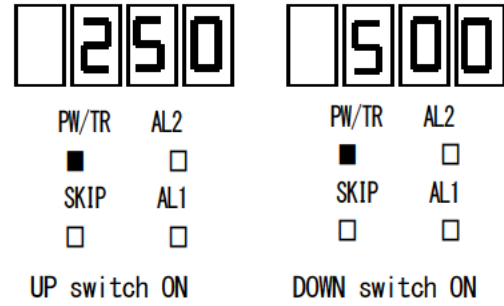

5-5-4. Change of alarm level

This section is used to change alarm levels.

- Press MODE switch for over 3 seconds, and maintenance mode starts.

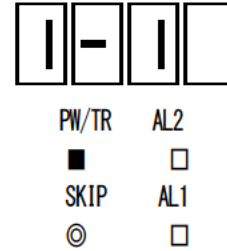

- Select 「1-2」 with UP/DOWN switch.

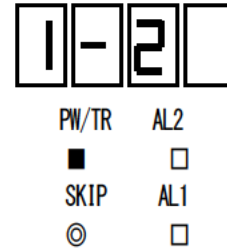

- When press SET switch, 1st alarm level(AL1) can be checked.
When press it again, 2nd alarm level(AL2) can be checked.

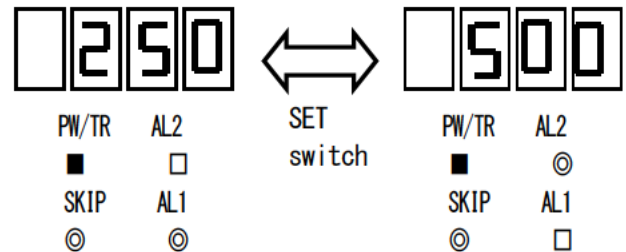

- To change alarm levels(AL1, AL2), adjust them with UP/DOWN switch and then, press SET switch.

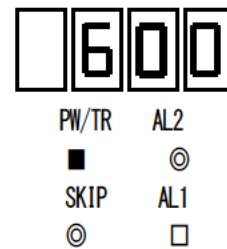

- To return detection mode, press MODE switch for over 3 seconds.
SKIP mode light turns off which shows detection mode.

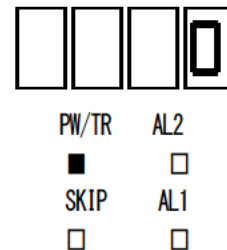

CAUTION

Gas alarm is not triggered except in detection mode.
When leave it alone on maintenance mode, this returns to detection mode automatically after 10 hours.

5—5—5. Confirmation of peak hold level

The highest reading level is held if gas concentration above preset alarm level in detection mode is detected.

- ① Press MODE switch for above 3 seconds to start maintenance mode.



PW/TR	AL2
■	<input type="checkbox"/>
SKIP	AL1
◎	<input type="checkbox"/>

- ② Select「1-P」with UP/DOWN switch.



PW/TR	AL2
■	<input type="checkbox"/>
SKIP	AL1
◎	<input type="checkbox"/>

- ③ Peak hold level can be checked with SET switch.



PW/TR	AL2
■	<input type="checkbox"/>
SKIP	AL1
◎	<input type="checkbox"/>

- ④ Press SET switch for above 3 seconds to release peak hold level.



PW/TR	AL2
■	<input type="checkbox"/>
SKIP	AL1
◎	<input type="checkbox"/>



PW/TR	AL2
■	<input type="checkbox"/>
SKIP	AL1
◎	<input type="checkbox"/>

- ⑤ Press SET switch to check whether it is cancelled or not.

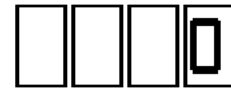

PW/TR	AL2
■	<input type="checkbox"/>
SKIP	AL1
◎	<input type="checkbox"/>

- ⑥ To return detection mode, press MODE switch for above 3 seconds. MAINTENANCE light turns off to show detection mode.



PW/TR	AL2
■	<input type="checkbox"/>
SKIP	AL1
○	<input type="checkbox"/>



CAUTION

Gas alarm is not triggered except in detection mode.

When leave it alone on maintenance mode, this returns to detection mode automatically after 10 hours.

5—5—6. Alarm test

This section is used to confirm alarm light, alarm buzzer, alarm relay contact and transmission condition to the outer equipment by giving same gas concentration signal (4–20mA) output.

WARNING

When make alarm test, (transmission test), announce it to respective department beforehand. Carry it out after making proper treatment (External signal output, alarm contact).

- ① Press SET switch for above 3 seconds to start alarm test mode. When it gets to alarm test mode, both SKIP light and display flash.

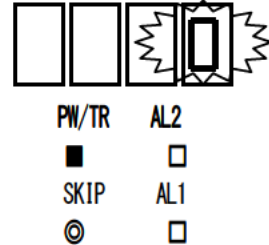

- ② Increase the reading with UP switch. When it reaches the first alarm level, AL1 light flashes and buzzer sounds (first alarm contact works). When it reaches the second alarm level, AL2 light flashes and buzzer sounds (2nd alarm contact works).

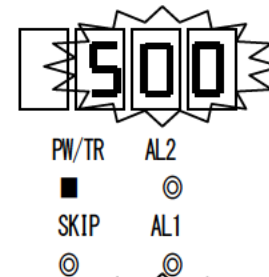
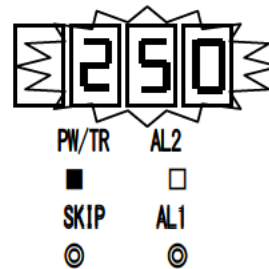

- ③ To stop the buzzing sound, press RESET switch. In this occasion, alarm light changes to steady light and it becomes self reset mode. To decrease reading below alarm level with DOWN switch, alarm light and alarm contact are cancelled.

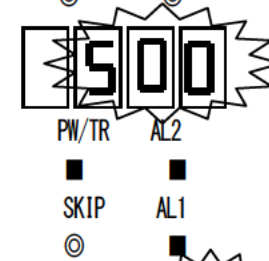

- ④ Press SET switch for above 3 seconds, and it returns detection mode. SKIP light turns off which shows detection mode.

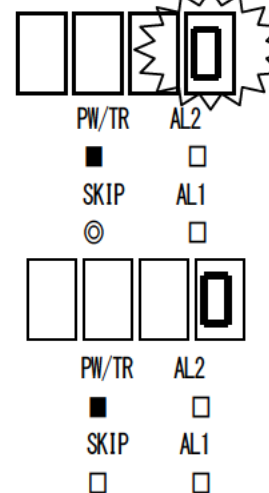

5—6. How to finish operation

When finish this operation, turn off power switch of this unit and turn off the main power (DC24V).



WARNING

- When finish this operation, do it after making point ship with the upper system (Centralized system).
- When finish this operation, check the external output and function of outer equipment to be connected with external alarm contact. Then, judge whether power can be shut off or not. When alarm contact is set on excitation (option), alarm contact works when make power (DC24V) off.

6.KINDS OF ALARM AND PERFORMANCE

6—1. Kinds of alarm

There are two kinds of alarms such as gas alarm and trouble alarm.

- Gas alarm: When detection gas reaches preset alarm level or exceeds it, this starts alarm.
《Latched mode→Self reset after reset operation.》

* NOTE

Alarm levels are adjusted at 1/4 (1st alarm) and 1/2 (2nd alarm) of full scale.
To prevent wrong operation, this unit provides alarm delayed circuit for 2 seconds.

- Trouble alarm: Abnormal condition in this unit is detected and gives a trouble alarm.
Except system trouble “E-00”, it is non-latched mode.
When return to normal from trouble condition, it starts again from the action of initial clear after power on see section 【9. TREATMENT AT ABNORMAL CASE】.

6—2. Gas alarm

6—2—1. Gas alarm action

(1) Display

① Gas concentration

When exceeds detection range (Over scale), LED shows “ $\cap \cap \cap \cap$ ”.

② Power light (Power: Green)

It keeps steady light.

③ Alarm light (AL1: Orange), (AL2: Red)

There are two alarm levels. When reading reaches each preset alarm level, or exceeds each preset alarm level, this starts flashing and then returns to continuous lighting after reset operation, (Standard).

(2) External output

① 4-20mA output

Electric current proportional to gas concentration. In case of over scale, the maximum output is 22mA.

② Alarm contact

When gas concentration reaches preset alarm level or it exceeds preset alarm level, relay contact work. Alarm relay contact is a latched mode. It returns self-reset mode when gas concentration decreases below preset level after reset operation.

* NOTE

Alarm pattern is shown in the attached sheet.

6—2—2. Counteraction at gas alarm

Reaction to leak gas

The counteraction at gas alarm shall follow to the client rule and immediate reaction shall be required. Generally, the following action is taken.

- ① Confirmation of indication value.

* NOTE

Instantaneous gas leak may get lower at confirmation time.

Except gas alarm, it gets alarm condition temporarily by noise or any other accidental conditions.

- ② Based on gas alarm control concentration, it keeps the safety by keeping away people from the monitoring area.
- ③ When gas concentration display is continued, close the gas valve and confirm that gas concentration gets lower enough.
- ④ Suppose that the leak gas is to remain and provide yourself with protection attire and tool away from danger, go to the leak site and check the gas residual condition by portable gas detector.
- ⑤ After checking that there is no danger, the treatment for gas leak shall be taken.

6—2—3. Gas alarm possibility except the case of gas detection

It may respond to interference gas

For interference gases, contact the nearest agent or RIKEN KEIKI.

It may be caused by drifting due to the change of long time elapsed sensor

Check the reading by daily check and make calibration through authorized service agent whenever necessary.

It may be caused by the noise generated from spherical machine

Revision of installation location, wirings and the addition etc. of noise measure parts between instrument and detector shall be required. This specific measures shall differ from the condition of each site.

It may receive a temporarily noise such as by thunder lightning etc.

When the cause and effects are understood, the measure for surge according to the condition can be taken.

7. MAINTENANCE CHECK

This is an important for security and safety. To maintain the security and enhance the reliability of safety, the reliability of safety, the regular maintenance check for it shall be absolutely necessary.

7 — 1. Frequency of maintenance and check items.

7 — 1 — 1. Daily check

This is the check items carried out by customer.

① Check of PW/TR light.

In normal operation, the light is at on condition.

② Check of LED reading

Check that LED reading is zero “0”.

If it is not “0”, check that gas is free around detector head and make zero adjustment at detector head side.



CAUTION

For the accurate zero adjustment, check it by “1-1 Zero adjustment” of maintenance mode.

③ Alarm test

Check that the alarm light flashes and buzzer sounds.



CAUTION

For the alarm test, refer to “5-5-6 Alarm test.”

7 — 1 — 2. Regular maintenance check

The following items shall be checked at regular check.

- ① Daily check
- ② Cleaning of this unit
- ③ Adjustments
- ④ Function check
- ⑤ Parts replacement
- ⑥ Others

7 — 2. Maintenance contract for regular check

To maintain the safety operation of the unit, it is recommended to keep the maintenance contract with service agent for regular maintenance, adjustment and overhaul etc including the gas sensitivity adjustment.

For the detail of maintenance contract, contact our nearest service agent or RIKEN KEIKI.

7—3. Replacement of sensor and parts.



CAUTION

For replacement of sensors and parts etc, contact our service agent or RIKEN KEIKI.

7—4. Treatment when operation is stopped or its installation place is moved.

7—4—1. Stop at normal operation

- Make the power switch off on the front panel.
- Make the power (DC24V) off at the supply side.

7—4—2. Installation when move its place

When move its place, refer to【4-3. Installation place】 about its moving place. Then, for wiring refer to 【4-6. Caution at wiring】.



CAUTION

When move its installation place, be sure to make gas calibration. The re-adjustment work including gas calibration shall be requested to contact our service agent or RIKEN KEIKI.

7—5. Storage and treatment when not use for a long time.

This model must be stored under the following environmental conditions.

- In a dark place under the normal temperature and humidity away from direct sunlight.
- In a place where gases, solvents or vapors are not present.



CAUTION

- When re-use it, be sure to make gas calibration.
- The re-adjustment and parts replacement etc including the gas calibration shall be contacted to our nearest agent or RIKEN KEIKI.

8. SCRAP OF PRODUCTS AND SENSORS

Regarding indicator/alarm unit complete, treat it in the same as industrial scrap (Non-flammable goods).

9. TREATMENT AT ABNORMAL CASE

9—1. Trouble alarm

Flashing of PW/TR light

- When PW/TR light is flashing, it is the condition that the following trouble may be caused.
Research its cause and take an appropriate action.
- The output from the unit at trouble shall be as follows.
4~20mA output : Fixed at 0.5mA
Trouble alarm contact: Relay contact works.

LED display	Trouble content	Main cause
E—00	System trouble	Memory trouble in the unit.
E—01	Connection trouble of detection head	Detector head disconnection, sensor disconnection, sensor cable disconnection.
E—04	Auto-zero trouble	Zero drift of the sensor is high

9—2. Counteraction at trouble alarm

When any trouble was found on this unit and detector head, contact our nearest agent or RIKEN KEIKI.

9—3. Before it is thought to be trouble

It may be originated from disconnection and short circuit between units.

- Check the wirings including peripheral equipment as well as detector head.
- Re-check the detection system and contact our nearest agent or RIKEN KEIKI.

There is the case of electrical line trouble such as shut-off of power.

- This will be treated by the re-check of stand-by battery, electrical line filter, insulation transformer etc or those addition.

9—4. Trouble shooting

(1) PW/TR light does not illuminate

<Cause and action>

- Is it OK with power cable connection?
Connect power cable.
- Is fuse disconnected?
Search the cause of disconnection and replace it after making counter-measures.
- Is power voltage normal?
Supply the rating power voltage.
- Is this power switch turned on?
Make power switch ON.

(2) Abnormal performance

<Cause and action>

- Sudden surge noise can be considered. When recover it, turn off the power and turn on the power again for re-start of operation.
When such takes place oftentimes, take an appropriate action for noise.

(3) No calibration available

<Cause and action>

- Is the calibration gas concentration correct?
Prepare the appropriate calibration gas.
- There is the possibility for sensor sensitivity drop.
The sensor replacement is required.

(4) PW/TR light flashing

① System trouble “E-00”

<Cause and action>

- Memory trouble inside of indicator/alarm unit.
Contact our nearest agent or RIKEN KEIKI.

② Sensor connection trouble “E-01”

<Cause and action>

- Non-connection of sensor, contact failure of connector and disconnection of sensor cable.
- Check “whether sensor is connected” or “the sensor cable connector is connected to the sensor. If can not be recovered, contact our nearest agent or RIKEN KEIKI.

(5) Fuse disconnection

<Performance>

- This unit can not work.

<Cause and action>

- The trouble of this unit or trouble of external power source can be considered. Search this cause and after taking its measures, replace the fuse with the designate one.

*** NOTE**

The fuse rating for this unit is “250V/1A T”.

10. DEFINITION OF WORD

LEL

The abbreviation LEL stands for Lower Explosive Limit.

Lower explosive limit

This represents the lowest concentration which can be ignited by source of ignition, hence the lowest concentration which can produce an explosion.

Calibration

Matching the equipment indication, reaching or set valve to the calibration gas concentration valve by using the calibration/standard gas.

Maintenance mode

When make maintenance of this unit, shut off the alarm and the output of signal showing the maintenance mode condition is displayed on the external output signal.

By this, the maintenance is carried out independently on this unit.

Press MODE switch for over 3 seconds to start the maintenance.

Initial clear

The output from the detector head fluctuates for a while after power on.

This function is to suppress alarm during this period. Also, signal output showing initial clear condition is given on external output.

Alarm delay time

To prevent the alarm error by noise intruded from the outside, this is the function to suspend the running temporarily.

1 1 . PRODUCT SPECIFICATION

1 1 — 1. Specifications

Model designation	:	NC-591
Detection gas	:	Combustible gases
Applicable detector head	:	New ceramic sensor type detector head
Detection signal	:	Direct signal from the sensor
Detector head cable	:	CVV 4-core or equivalent
Distance to the detector head	:	Max 1.25km with CVV(1.25mm ²) cable.
Output signal	:	4 ~ 20mADC, non-isolation (Resistive load below 300Ω)
Gas concentration	:	4 ~ 20mADC (Linear up to 22mA)
At trouble	:	0.5mADC
At initial clear	:	2.5mADC
At maintenance	:	2.5mADC
Alarm performance	:	Latched mode (Standard), non-latched mode(option) or lock-in(option)
1st alarm	:	Orange light (AL1) flashing(steady light after reset operation)
Relay contact	:	Non-exciting at normal(exciting at alarmstandard) or exciting at normal(non-exciting at alarm option) Potential free contact 1a(standard) or 1b(option)
2nd alarm	:	Red light(AL2) flashing(steady light after reset operation)
Relay contact	:	Non-exciting at normal(exciting at alarmstandard) or exciting at normal(non-exciting at alarm option) Potential free contact 1a(standard) or 1b(option)
Contact rating	:	0.5A at 100VAC, 1.5A at 30VDC(Resistive load)
Trouble alarm	:	
Alarm performance	:	Non-latched mode
Alarm display	:	Green light(PW/TR) flashing
Relay contact	:	Non-exciting at normal(exciting at alarmstandard) or exciting at normal(non-exciting at alarm option) Potential free contact 1a(standard) or 1b(option)
Self-diagnostic function	:	System failure, detector head connection failure.
Initial clear time	:	Approx 25 seconds
Several settings	:	By remote PC (uses exclusive cable)
Operating temp. & humidity	:	0 ~ 40°C, 10 ~ 90%RH (Non-condensing)
Power requirement	:	24VDC ± 10%
Applicable power cable	:	CVV 2-core
Power consumption (including detection head)	:	Max 10W(with single case) or Max 17VA(with multi-unit case)
Structure	:	Housing type for the case, front identification card type, non-explosion proof type.
Dimensions & weight	:	Approx 36(W) x 72(H) 134(D)mm, Approx 0.1kg(unit only)

* Specifications subject to change without notice.

1 1 — 2. Product composition

Standard compositions

- Indicator/alarm unit Model NC-591
- Operating instruction manual...1 vol.
- Spare fuse...Depends on ordered quantity of the unit.

1 ~ 10 units	1 pce
11 ~ 20 units	2 pcs
21 ~ 50 units	3 pcs
51 units and above	4 pcs